

# SUBMARINE LEAD-ACID BATTERY PERFORMANCE

*To appear in the (refereed) proceedings of the Mathematics-in-Industry Study Group, held at the University of South Australia, Adelaide, 3–7 Feb 2003.*

Mark McGuinness<sup>1</sup> and Basil Benjamin<sup>2</sup>

The lead-acid batteries used to power conventional submarines while they are submerged undergo unique deep discharge and rapid recharge histories. An improved mathematical model is required to calculate state of charge and to predict the performance of these batteries. Three models are considered — a detailed electrochemical kinetic model, a hydraulic analogue model, and a parametric model.

The detailed electrochemical model is developed in one dimension, resulting in coupled nonlinear convection-diffusion equations with complicated boundary conditions. The resulting non-dimensionalised equations are solved asymptotically for the narrow boundary layers that develop in the electrolyte near the cell plates, resulting in a single linear diffusion equation with nonlinear boundary conditions that explicitly capture the boundary layer behaviour. Numerical solutions and comparison with data is needed.

The hydraulic model is modified and tested in a preliminary manner, and looks promising as a predictive model. The parametric model also looks promising, but needs to be fitted to data and tested further.

## 1. Introduction

The Australian Submarine Corporation (ASC) asked MISG to model a typical lead acid battery used to power conventional (non-nuclear) sub-

---

<sup>1</sup>School of Math. & Comp. Sci., Victoria University of Wellington, PO Box 600, Wellington, NZ. Email Mark.McGuinness@vuw.ac.nz.

<sup>2</sup>School of Mathematics and Statistics, University of South Australia, Mawson Lakes SA 5095, Australia. Email Basil.Benjamin@unisa.edu.au.

marines while submerged. The use of these batteries features large currents and rapid recharging, in a pattern of cyclic operation (Fig. 1). Such use leads to nonlinear battery performance with memory, dependent on past history. Existing models have a focus on discharge performance from the fully charged state, and do not appear to provide satisfactory estimates of battery reserves for predicting submarine performance.

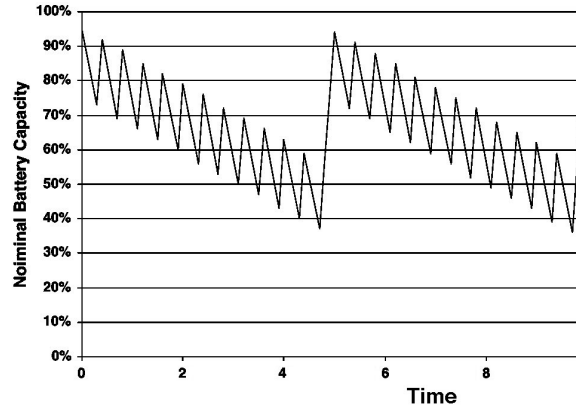

Figure 1: A typical discharge history for a submarine battery.

ASC is seeking an improved mathematical model of lead-acid battery performance, which they want to incorporate into an overall Submarine Performance Model (SPM), written in Matlab.

In particular, ASC have asked

- What are the key parameters to enable specification of a battery
- Can these be related to define performance
- Can these be used to define a generic model of a lead acid battery which can provide improved prediction of performance under cyclic operation.
- What is the best technique to model the battery in the proposed SPM environment:
  - Electrochemical model
  - Electric model
  - Parametric Model

## 2. Some Battery Basics

Typical submarine batteries are conventional flooded lead acid cells. Each plate in the cell is essentially flat or planar, although the positive plate is composed of tubes arranged in a plane, filled with porous lead oxide. The negative plate is a stretched metal grid, coated with porous lead. The gap (face to face) between adjacent positive and negative plates (or electrodes) is usually in the order of 1mm. There is a porous spacer in this gap, to prevent contact between adjacent electrodes. A representative cutaway view is presented in Fig. (2)

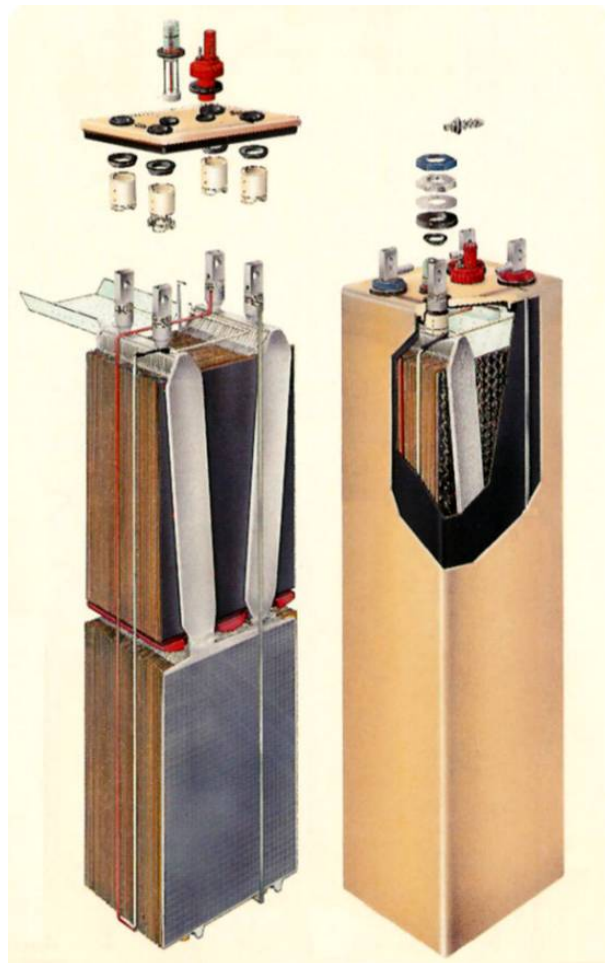
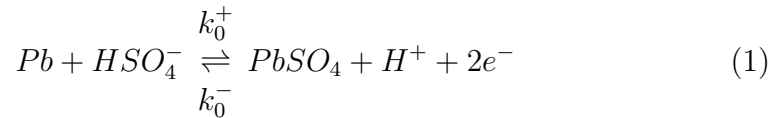

Figure 2: A cutaway view of the construction of a typical lead-acid batteries as used in submarines.

The batteries may be water-cooled at their top ends, and usually the acid is air-lifted from the bottom of the battery and sprinkled back over the top of the plates to prevent acid stratification. We estimated that this would completely overturn the acid in a day or two. Hence we ignored any vertical variation in the specific gravity of the acid. There is good evidence that vertical variations in electric field do give a vertical variation in reaction rate (1; 2), but that ignoring this variation still gives good results for battery performance (1). The batteries are typically operated with several short cycles per day, and a larger recharge cycle every few days or so (see Fig. 1), although this pattern might be rather different during a mission.

The chemical reactions generally agreed (1) to occur in a lead-acid battery are, on the negative plate:



and on the positive plate:

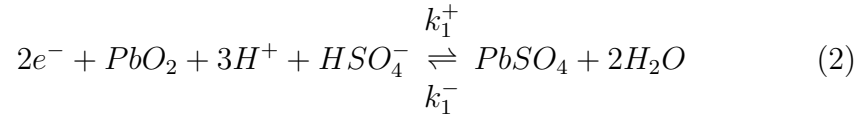

During discharge, the (net) reactions proceed from left to right with reaction rates  $k_0^+$ ,  $k_1^+$ , and during charge they proceed from right to left with reaction rates  $k_0^-$ ,  $k_1^-$ . The state of charge of a battery is accurately given by the specific gravity of the electrolyte, that is, by the amount of sulphuric acid remaining. As a battery discharges, lead sulphate builds up on both plates, and can block transport or reduce the surface area accessible for reaction.

Generally there are three stages for charging a typical submarine battery, a constant power stage (with voltage increasing to about 2.4V per cell), followed by a constant voltage stage until current drops to a very small value, followed by a constant current stage (with higher voltages) to

### 3. A Detailed Electrochemical Model

#### 3.1 The Model

The battery cell consists of a lead oxide plate (the positive electrode) and a lead plate (the negative electrode) which are separated by a thin gap  $O(1)$ mm filled with a sulphuric acid solution which partially ionises to form  $H^+$  and  $HSO_4^-$  ions. The plates are relatively flat but porous to increase the surface area of reaction. In addition both plates have large lateral dimensions compared to their separation (in a submarine cell they typically have area of about  $0.5\text{m}^2$ ). Given the geometry of the cell it is sensible to look for a model with only one spatial dimension  $x$  running across the width of the cell with  $x = 0$  being the position of the surface of the negative electrode and  $x = L$  being the position of the surface of the positive electrode, as illustrated in Fig. (3).

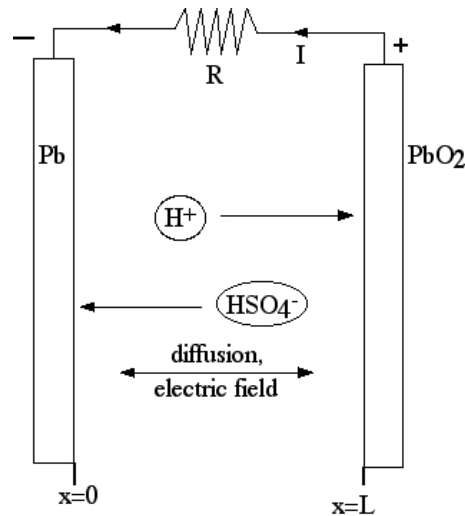

Figure 3: A sketch illustrating key features of the detailed electrochemical model. The horizontal scale is exaggerated compared to the vertical scale.

The chemical reactions taking place in the battery are noted in the previous section. We take  $x = 0$  at the negative electrode and  $x = L$  at the positive electrode. We make the assumption that the reactions are in quasi static equilibrium. In other words we assume that the diffusive processes that bring the ions  $H^+$  and  $HSO_4^-$  into contact with the electrodes occur over a much longer timescale than the reaction itself. This

assumption is supported by noting that the timescale for reaction kinetics is of the order of seconds for lead-acid cells (3), much shorter than typical charge/discharge times in the submarine application. As a first step we also assume that the reactions on both electrodes are primarily controlled by the activation energies (*i.e.* the effective concentrations) of  $H^+$  and  $HSO_4^-$  and the surface concentration of  $PbSO_4$  which we write as

$$\begin{aligned} [H^+] &= H \text{ m}^{-3}, & [HSO_4^-] &= S \text{ m}^{-3}, \\ \text{on } x = L \quad [PbSO_4] &= \gamma^+ \text{ m}^{-2}, & \text{on } x = 0 \quad [PbSO_4] &= \gamma^- \text{ m}^{-2}. \end{aligned}$$

In practice the supply of electrons and water will always be at nearly uniform concentrations. Note that the units for concentration are numbers of ions per unit volume or per unit area. We are assuming that there is always sufficient lead and lead oxide available for reaction, and we ignore in this work any effects of lead sulphate buildup in pores in the electrodes, blocking access of electrolyte to electrodes, and altering the electric field there. Future extension of this work would be useful, in which the model is modified to include effects due to variations in the available surface concentrations of  $Pb$  and  $PbO_2$ . The reaction equilibria are thus given by

$$S = K_0 \gamma^- H \quad \text{on } x = 0, \quad \gamma^+ = K_1 H^3 S \quad \text{on } x = L, \quad (3)$$

where

$$K_0 = \frac{k_0^- [e]^2}{k_0^+ [Pb] \delta},$$

and

$$K_1 = \frac{k_1^+ [PbO_2] \delta [e]^2}{k_1^-},$$

and where  $[e]$  is the concentration of electrons, and  $\delta$  is a measure of the width of the region of solute that is at equilibrium with the surface of the electrode. In the solution between the two electrodes the ions  $H^+$  and  $HSO_4^-$  diffuse and advect under the action of an electric field  $\mathbf{E}$  which we can write in terms of an electric potential  $\phi$  as follows:

$$\mathbf{E} = -\phi_x \mathbf{e}_x,$$

where  $\mathbf{e}_x$  is a unit vector in the  $x$ -direction and  $\phi_x \equiv \frac{\partial \phi}{\partial x}$ . Balancing Stokes' drag on a  $HSO_4^-$  ion with the force acting on it due to the electric field gives the ion's velocity (in the absence of diffusion) as (see, e.g., (4))

$$v_s = \frac{q\phi_x}{6\pi\mu a},$$

where  $q$  is the charge on an electron,  $\mu$  is the viscosity of water and  $a$  is the Stokes radius of the  $HSO_4^-$  ion. In addition the diffusion coefficient  $D_s$  is given by the Stokes-Einstein relation (4; 5)

$$D_s = \frac{kT}{6\pi\mu a},$$

where  $k$  is Boltzmann's constant and  $T$  is the absolute temperature of the solution. Using these two relations we can write down the advection diffusion equation for  $S$

$$S_t = D_s \left( S_{xx} - \frac{q}{kT} \frac{\partial}{\partial x} (S\phi_x) \right),$$

and a similar development yields the advection diffusion equation for  $H$

$$H_t = D_h \left( H_{xx} + \frac{q}{kT} \frac{\partial}{\partial x} (H\phi_x) \right),$$

where  $D_h = kT/(6\pi\mu b)$  is the diffusion coefficient of hydrogen ions and  $b$  is the Stokes radius of a hydrogen ion. Since hydrogen ions are much smaller than  $HSO_4^-$  ions it is tempting to think that  $D_h \gg D_s$ , but this assumption is false because hydrogen ions do not exist as isolated entities in solution but rather as a complex formed with a number of water molecules and its Stokes' radius is thus comparable with that of an  $HSO_4^-$  ion (which is probably also hydrated).

The rate of change of the lead sulphate surface concentration on the positive electrode may be seen, on consulting the chemical reaction, to be equal to the flux of  $HSO_4^-$  ions arriving at the electrode and equal to one third the flux of hydrogen ions arriving at the electrode. This leads to the following relations:

$$\left. \begin{aligned} \frac{d\gamma^+}{dt} &= -D_s \left( S_x - \frac{q}{kT} (S\phi_x) \right) \\ \frac{d\gamma^+}{dt} &= -\frac{1}{3} D_h \left( H_x + \frac{q}{kT} (H\phi_x) \right) \end{aligned} \right\} \text{ on } x = L \quad (4)$$

A similar balance on the negative electrode gives

$$\left. \begin{aligned} \frac{d\gamma^-}{dt} &= D_s \left( S_x - \frac{q}{kT} (S\phi_x) \right) \\ \frac{d\gamma^-}{dt} &= -D_h \left( H_x + \frac{q}{kT} (H\phi_x) \right) \end{aligned} \right\} \text{ on } x = 0. \quad (5)$$

The electric potential  $\phi$  obeys Poisson's equation (a form of Gauss's law):

$$\frac{\partial}{\partial x}(\varepsilon\phi_x) = -\rho,$$

where  $\varepsilon$  is the dielectric constant of the medium and  $\rho$  is the charge density in the medium ( $\text{As m}^{-3}$ ). Allowing for a surface density  $p \text{ m}^{-2}$  of positive charge carriers on the surface of the positive electrode and a surface density  $f \text{ m}^{-2}$  of negative charge carriers on the surface of the negative electrode Poisson's equation yields

$$\frac{\partial}{\partial x}(\varepsilon\phi_x) = q(S - H + f\delta(x) - p\delta(x - L)).$$

Boundary conditions on this differential equation are provided by specifying an arbitrary reference potential  $\phi$  and a symmetry condition (to ensure that the total electric field at a distance from the plates is zero). These boundary conditions are respectively

$$\begin{aligned}\phi &= 0 & \text{on } x = 0_-, \\ \phi_x|_{x=0_-} &= -\phi_x|_{x=L_+}.\end{aligned}$$

Furthermore, since the model conserves charge within the cell, if the total charge is zero at time  $t = 0$  then it is so for all time; then integrating Poisson's equation for the electric field from  $x = 0_-$  to  $x = L_+$  gives

$$\phi_x|_{x=L_+} - \phi_x|_{x=0_-} = \frac{q}{\varepsilon} \int_{0_-}^{L_+} \rho dx \quad (6)$$

$$= \frac{q}{\varepsilon} \left( p - f + \int_0^L (H - S) dx \right) \quad (7)$$

$$= \frac{\text{total charge}}{\varepsilon A} \quad (8)$$

$$= 0 \quad \text{at all times.} \quad (9)$$

It follows that

$$\phi_x|_{x=0_-} = \phi_x|_{x=L_+} = 0.$$

Note that the dielectric constant of water  $\varepsilon_w \approx 80\varepsilon_0$  and that the dielectric constant in the conducting electrodes is  $\varepsilon_0$ , the permittivity of free space. At this stage it is helpful to integrate the  $\delta$  functions out of



Poisson's equation to leave boundary conditions posed on  $x = 0^+$  and  $x = L^-$  which lie just within the fluid; this gives rise to the following:

$$\phi_{xx} = \frac{q}{\varepsilon_w} (S - H) \quad 0 < x < L, \quad (10)$$

$$\phi_x|_{x=0^+} = \frac{qf}{\varepsilon_w}, \quad (11)$$

$$\phi_x|_{x=L^-} = \frac{qp}{\varepsilon_w}, \quad (12)$$

$$\phi = 0, \quad x = 0 + . \quad (13)$$

Finally we need to give conditions on the rate of change of charge carriers on the surface of the electrodes. By referring to the chemical reactions one can see that these are

$$\frac{dp}{dt} = 2 \frac{d\gamma^+}{dt} - \frac{I}{Aq} \quad \text{on } x = L, \quad (14)$$

$$\frac{df}{dt} = 2 \frac{d\gamma^-}{dt} - \frac{I}{Aq} \quad \text{on } x = 0, \quad (15)$$

where  $I$  (amps) is the current flowing in the circuit being powered by the cell (that is,  $I > 0$  for discharge) and  $A \text{ m}^2$  is the area of the electrodes. The current flowing in the circuit is powered by the potential differences between the two plates and, where the electrical resistance of the circuit is  $R$  Ohms, is given by

$$I = \frac{\phi|_{x=L^+} - \phi|_{x=0^-}}{R} = \frac{\phi|_{x=L^-} - \phi|_{x=0^+}}{R}. \quad (16)$$

Estimates for the parameters and for typical values of variables (for rescaling) in the problem are given below

$$\begin{array}{ll} L \sim 10^{-3} \text{ m}, & q = 1.60 \times 10^{-19} \text{ A s}, \\ \varepsilon_0 = 8.85 \times 10^{-12} \text{ A s V}^{-1} \text{ m}^{-1} & \varepsilon_w \sim 7 \times 10^{-10} \text{ A s V}^{-1} \text{ m}^{-1}, \\ a \sim 10^{-10} \text{ m}, & b \sim 10^{-10} \text{ m}, \\ \mu \sim 10^{-3} \text{ kg m}^{-1} \text{ s}^{-1}, & k = 1.381 \times 10^{-23} \text{ N m K}^{-1}, \\ H_0 \sim 6 \times 10^{29} \text{ m}^{-3}, & S_0 \sim 6 \times 10^{29} \text{ m}^{-3}, \\ T \sim 300 \text{ K} & R \sim 10 \text{ Ohms} \\ A \sim 10^{-1} \text{ m}^2. & \end{array}$$

### 3.2 Non-dimensionalisation of the model

We nondimensionalise the model, comprised of equations (3)-(16), assuming that diffusive effects balance electrostatic effects in the advection diffusion equations for  $H$  and  $S$  (4)-(4). This leads to the scalings

$$\begin{aligned} x &= Lx^*, & t &= \frac{L^2}{D_s}t^*, & \phi &= \frac{kT}{q}\phi^*, & I &= \frac{kT}{qR}I^*, \\ H &= H_0H^*, & S &= H_0S^*, & f &= H_0Lf^*, & p &= H_0Lp^*, \\ \gamma^+ &= H_0L\gamma^{+*}, & \gamma^- &= H_0L\gamma^{-*}. \end{aligned}$$

and hence to the following dimensionless model:

$$\left. \begin{aligned} \frac{\partial S^*}{\partial t^*} &= \frac{\partial^2 S^*}{\partial x^{*2}} - \frac{\partial}{\partial x^*} \left( S^* \frac{\partial \phi^*}{\partial x^*} \right), \\ \frac{\partial H^*}{\partial t^*} &= \kappa \left( \frac{\partial^2 H^*}{\partial x^{*2}} + \frac{\partial}{\partial x^*} \left( H^* \frac{\partial \phi^*}{\partial x^*} \right) \right), \\ \frac{\partial^2 \phi^*}{\partial x^{*2}} &= \Gamma (S^* - H^*) \end{aligned} \right\} \text{in } 0 < x^* < 1 \quad (17)$$

together with the boundary conditions

$$\left. \begin{aligned} S^* &= k_0 H^* \gamma^{-*} \\ \frac{d\gamma^{-*}}{dt^*} &= \left( \frac{\partial S^*}{\partial x^*} - S^* \frac{\partial \phi^*}{\partial x^*} \right) \\ \frac{d\gamma^{-*}}{dt^*} &= -\kappa \left( \frac{\partial H^*}{\partial x^*} + H^* \frac{\partial \phi^*}{\partial x^*} \right) \\ \frac{\partial \phi^*}{\partial x^*} &= \Gamma f^* \\ \phi^* &= 0 \end{aligned} \right\} \text{on } x^* = 0 \quad (18)$$

and

$$\left. \begin{aligned} \gamma^{+*} &= k_1 H^{*3} S^* \\ \frac{d\gamma^{+*}}{dt^*} &= - \left( \frac{\partial S^*}{\partial x^*} - S^* \frac{\partial \phi^*}{\partial x^*} \right) \\ \frac{d\gamma^{+*}}{dt^*} &= -\frac{\kappa}{3} \left( \frac{\partial H^*}{\partial x^*} + H^* \frac{\partial \phi^*}{\partial x^*} \right) \\ \frac{\partial \phi^*}{\partial x^*} &= \Gamma p^* \end{aligned} \right\} \text{on } x^* = 1 \quad (19)$$

and the relations

$$\frac{df^*}{dt^*} = 2 \frac{d\gamma^{-*}}{dt^*} - \lambda I^*, \quad (20)$$

$$\frac{dp^*}{dt^*} = 2 \frac{d\gamma^{+*}}{dt^*} - \lambda I^*, \quad (21)$$

$$I^* = \phi^*|_{x^*=1^-} - \phi^*|_{x=0^+}. \quad (22)$$

Here the dimensionless parameters in the model are given by

$$\begin{aligned} \Gamma &= \frac{qH_0L^2}{\varepsilon_w kT}, & \lambda &= \frac{LkT}{q^2RAD_S H_0}, & \kappa &= \frac{D_H}{D_S}, \\ k_0 &= K_0 H_0 L, & k_1 &= \frac{K_1 H_0^3}{L}. \end{aligned} \quad (23)$$

Henceforth we will drop the asterisks from the dimensionless variables.

### 3.3 Asymptotic analysis of the model

Substituting typical parameter values into the relation for  $\Gamma$  and  $\lambda$  given in (23) we estimate  $\Gamma \sim 5 \times 10^{12}$ ,  $\lambda \sim 4 \times 10^{-2}$ . Note that the value of the resistance  $R$  substituted into the formula for  $\lambda$  depends on the use being made of the battery and hence  $\lambda$  may vary (but is nevertheless  $\mathcal{O}(1)$ ). Indeed, operation of the batteries is better modelled with a resistance and a back EMF in practice, and a constant power regime is a more faithful approximation to the intended discharge of the batteries. For simplicity for now, we just use a resistance. For the reasons mentioned above we expect  $\kappa$  to be an  $\mathcal{O}(1)$  parameter. In addition we also expect  $k_1$  and  $k_2$  to be  $\mathcal{O}(1)$  parameters. Since there is one dominant large parameter  $\Gamma$  in this model and there is some doubt about the values of the other parameters in the model (although none are particularly large or small) we will make the assumption that throughout the rest of the analysis  $\lambda$ ,  $\kappa$ ,  $k_0$  and  $k_1$  are all of order one.

#### Outer Region.

Inspection of equation (17c) reveals that  $S \approx H$  in the bulk of the cell (charge neutrality). We therefore introduce an outer region lying between

the two plates, denote variables in this region with the superscript  $(c)$  and make the following asymptotic expansion:

$$H^{(c)} = H_0^{(c)} + \dots, \quad S^{(c)} = S_0^{(c)} + \dots, \quad \phi^{(c)} = \phi_0^{(c)} + \dots.$$

Substituting the above into (17) gives, to leading order,

$$\begin{aligned} \frac{\partial H_0^{(c)}}{\partial t} &= \kappa \left( \frac{\partial^2 H_0^{(c)}}{\partial x^2} + \frac{\partial}{\partial x} \left( H_0^{(c)} \frac{\partial \phi_0^{(c)}}{\partial x} \right) \right), \\ \frac{\partial S_0^{(c)}}{\partial t} &= \left( \frac{\partial^2 S_0^{(c)}}{\partial x^2} - \frac{\partial}{\partial x} \left( S_0^{(c)} \frac{\partial \phi_0^{(c)}}{\partial x} \right) \right), \\ S_0^{(c)} &= H_0^{(c)}. \end{aligned} \tag{24}$$

Manipulation of these equations leads to a single diffusion equation for  $H_0^{(c)}$  and an equation for the potential  $\phi_0^{(c)}$ :

$$\frac{\partial H_0^{(c)}}{\partial t} \left( 1 + \frac{1}{\kappa} \right) = 2 \frac{\partial^2 H_0^{(c)}}{\partial x^2}, \tag{25}$$

$$\frac{\partial}{\partial x} \left( H_0^{(c)} \frac{\partial \phi_0^{(c)}}{\partial x} \right) = \left( \frac{1 - \kappa}{1 + \kappa} \right) \frac{\partial^2 H_0^{(c)}}{\partial x^2}. \tag{26}$$

Together with (24) this forms a fourth-order system for  $(H_0^{(c)}, S_0^{(c)}, \phi_0^{(c)})$  in contrast to the original system (17) which is sixth-order. Hence we introduce boundary layer regions in the vicinity of each electrode in order to satisfy the boundary conditions on the problem. The boundary conditions on the fourth-order system come from matching with these boundary layers.

### The boundary layer about the negative electrode: Inner region 0.

In this region we rescale  $x$  with  $\Gamma^{-1/2}$  (assuming a 1 molar activity for the  $H^+$  ions this corresponds to considering a dimensional length scale of about  $10^{-9}\text{m}$ ), denote variables by the superscript  $(i)$  and make the following asymptotic expansion:

$$\begin{aligned} x &= \Gamma^{-1/2} z, & H^{(i)} &= H_0^{(i)} + \frac{H_1^{(i)}}{\Gamma^{1/2}} + \dots, & S^{(i)} &= S_0^{(i)} + \frac{S_1^{(i)}}{\Gamma^{1/2}} + \dots, \\ \phi^{(i)} &= \phi_0^{(i)} + \frac{\phi_1^{(i)}}{\Gamma^{1/2}} + \dots, & f &= \Gamma^{-1/2} f_0 + \dots, & \gamma^- &= \gamma_0^- + \dots. \end{aligned}$$

Substituting into (17) gives to leading order

$$\frac{\partial^2 H_0^{(i)}}{\partial z^2} + \frac{\partial}{\partial z} \left( H_0^{(i)} \frac{\partial \phi_0^{(i)}}{\partial z} \right) = 0, \quad (27)$$

$$\frac{\partial^2 S_0^{(i)}}{\partial z^2} - \frac{\partial}{\partial z} \left( S_0^{(i)} \frac{\partial \phi_0^{(i)}}{\partial z} \right) = 0, \quad (28)$$

$$\frac{\partial^2 \phi_0^{(i)}}{\partial z^2} = S_0^{(i)} - H_0^{(i)}, \quad (29)$$

in  $0 < z < \infty$ , which are to be solved using the following boundary conditions on  $z = 0$ :

$$\frac{\partial H_0^{(i)}}{\partial z} + H_0^{(i)} \frac{\partial \phi_0^{(i)}}{\partial z} = 0, \quad (30)$$

$$\frac{\partial S_0^{(i)}}{\partial z} - S_0^{(i)} \frac{\partial \phi_0^{(i)}}{\partial z} = 0, \quad (31)$$

$$\frac{\partial \phi_0^{(i)}}{\partial z} = f_0, \quad (32)$$

$$\phi_0^{(i)} = 0. \quad (33)$$

We can solve (27) and (28) in conjunction with the boundary conditions (30) and (31) to obtain the following expressions

$$H_0^{(i)} = B(t) \exp(-\phi_0^{(i)}), \quad S_0^{(i)} = A(t) \exp(\phi_0^{(i)}). \quad (34)$$

Substituting these into (29) gives the following second order differential equation for  $\phi_0^{(i)}$ :

$$\frac{\partial^2 \phi_0^{(i)}}{\partial z^2} = A(t) \exp(\phi_0^{(i)}) - B(t) \exp(-\phi_0^{(i)}), \quad (35)$$

which we can integrate once to obtain

$$\left( \frac{\partial \phi_0^{(i)}}{\partial z} \right)^2 = 2(A(t) \exp(\phi_0^{(i)}) + B(t) \exp(-\phi_0^{(i)})) + h(t), \quad (36)$$

where  $h(t)$  is an arbitrary function of time. Matching to the outer solution at leading order gives the conditions  $(\phi_0^{(i)})_z \rightarrow 0$  and  $(\phi_0^{(i)})_{zz} \rightarrow 0$  as  $z \rightarrow \infty$ ,

which in turn leads to the conclusion that  $h(t) = -2\sqrt{A(t)B(t)}$ . It follows that (36) can be rewritten as

$$\frac{\partial \phi_0^{(i)}}{\partial z} = \pm \sqrt{2} \left( A(t)^{1/2} \exp(\phi_0^{(i)}/2) - B(t)^{1/2} \exp(-\phi_0^{(i)}/2) \right).$$

We can integrate this to obtain  $\phi_0^{(i)}$  and the corresponding expression for  $(\phi_0^{(i)})_z$

$$\phi_0^{(i)} = 2 \ln \left( \left( \frac{B(t)}{A(t)} \right)^{1/4} \tanh \left( \mp \frac{(A(t)B(t))^{1/4}}{\sqrt{2}} (z + z_0(t)) \right) \right), \quad (37)$$

$$\frac{\partial \phi_0^{(i)}}{\partial z} = \frac{2\sqrt{2}(A(t)B(t))^{1/4}}{\sinh \left( \sqrt{2}(A(t)B(t))^{1/4}(z + z_0(t)) \right)}, \quad (38)$$

where  $z_0$  is a constant of integration. The boundary conditions (32) and (33) then give rise to the conditions

$$f_0 \sinh \left( \sqrt{2}(A(t)B(t))^{1/4} z_0(t) \right) = 2\sqrt{2}(A(t)B(t))^{1/4}, \quad (39)$$

$$\tanh \left( \frac{(A(t)B(t))^{1/4}}{\sqrt{2}} z_0(t) \right) = \left( \frac{A(t)}{B(t)} \right)^{1/4}, \quad (40)$$

where the negative sign has been discarded as unphysical. The far field behaviour of  $H_0^{(i)}$ ,  $S_0^{(i)}$  and  $\phi_0^{(i)}$  follows from (37) and (34) and is

$$H_0^{(i)} \rightarrow (A(t)B(t))^{1/2}, \quad S_0^{(i)} \rightarrow (A(t)B(t))^{1/2}, \quad \phi_0^{(i)} \rightarrow \frac{1}{2} \ln \left( \frac{B(t)}{A(t)} \right) \quad (41)$$

as  $z \rightarrow \infty$ .

We proceed to next order in the inner region with the goal of finding the flux of  $H$  and  $S$  on the edge of the outer region. Doing so we obtain the following equations for  $(H_1^{(i)}, S_1^{(i)}, \phi_1^{(i)})$ :

$$\frac{\partial}{\partial z} \left( \frac{\partial H_1^{(i)}}{\partial z} + H_0^{(i)} \frac{\partial \phi_1^{(i)}}{\partial z} + H_1^{(i)} \frac{\partial \phi_0^{(i)}}{\partial z} \right) = 0 \quad (42)$$

$$\frac{\partial}{\partial z} \left( \frac{\partial S_1^{(i)}}{\partial z} - S_0^{(i)} \frac{\partial \phi_1^{(i)}}{\partial z} - S_1^{(i)} \frac{\partial \phi_0^{(i)}}{\partial z} \right) = 0, \quad (43)$$

in  $0 < z < \infty$ , with boundary conditions

$$\left( \frac{\partial H_1^{(i)}}{\partial z} + H_0^{(i)} \frac{\partial \phi_1^{(i)}}{\partial z} + H_1^{(i)} \frac{\partial \phi_0^{(i)}}{\partial z} \right) = -\frac{1}{\kappa} \frac{d\gamma_0^-}{dt} \quad (44)$$

$$\left( \frac{\partial S_1^{(i)}}{\partial z} - S_0^{(i)} \frac{\partial \phi_1^{(i)}}{\partial z} - S_1^{(i)} \frac{\partial \phi_0^{(i)}}{\partial z} \right) = \frac{d\gamma_0^-}{dt}, \quad (45)$$

on  $z = 0$ . Integrating gives

$$\left( \frac{\partial H_1^{(i)}}{\partial z} + H_0^{(i)} \frac{\partial \phi_1^{(i)}}{\partial z} + H_1^{(i)} \frac{\partial \phi_0^{(i)}}{\partial z} \right) = -\frac{1}{\kappa} \frac{d\gamma_0^-}{dt} \quad (46)$$

$$\left( \frac{\partial S_1^{(i)}}{\partial z} - S_0^{(i)} \frac{\partial \phi_1^{(i)}}{\partial z} - S_1^{(i)} \frac{\partial \phi_0^{(i)}}{\partial z} \right) = \frac{d\gamma_0^-}{dt}, \quad (47)$$

in  $0 < z < \infty$ .

### Matching the inner region 0 to the outer region.

Matching the leading order outer solution to the inner solution in region 0 as  $z \rightarrow \infty$  (see (41)), using Van Dyke's matching principle, we obtain the following conditions on  $(H_0^{(c)}, S_0^{(c)}, \phi_0^{(c)})$  at  $x = 0$ :

$$\phi_0^{(c)}|_{x=0} = \frac{1}{2} \ln \left( \frac{B(t)}{A(t)} \right), \quad (48)$$

$$H_0^{(c)}|_{x=0} = S_0^{(c)}|_{x=0} = (A(t)B(t))^{1/2}. \quad (49)$$

The fluxes of  $H_0^{(c)}$  and  $S_0^{(c)}$  match to the first order fluxes of  $H^{(i)}$  and  $S^{(i)}$ , namely to  $(H_1^{(i)})_z + H_0^{(i)}(\phi_1^{(i)})_z + H_1^{(i)}(\phi_0^{(i)})_z$  and  $(S_1^{(i)})_z - S_0^{(i)}(\phi_1^{(i)})_z - S_1^{(i)}(\phi_0^{(i)})_z$  respectively. Using (47) to evaluate these, and matching to the outer solution, gives rise to these conditions

$$\left( \frac{\partial H_0^{(i)}}{\partial x} + H_0^{(i)} \frac{\partial \phi_0^{(i)}}{\partial x} \right) \Big|_{x=0} = -\frac{1}{\kappa} \frac{d\gamma_0^-}{dt},$$

$$\left( \frac{\partial S_0^{(i)}}{\partial x} - S_0^{(i)} \frac{\partial \phi_0^{(i)}}{\partial x} \right) \Big|_{x=0} = \left( \frac{\partial H_0^{(i)}}{\partial x} - H_0^{(i)} \frac{\partial \phi_0^{(i)}}{\partial x} \right) \Big|_{x=0} = \frac{d\gamma_0^-}{dt}.$$

It is helpful to rewrite these conditions in the form

$$\left. \frac{\partial H_0^{(i)}}{\partial x} \right|_{x=0} = \frac{1}{2\kappa}(\kappa - 1) \frac{d\gamma_0^-}{dt}, \quad (50)$$

$$H_0^{(i)} \left. \frac{\partial \phi_0^{(i)}}{\partial x} \right|_{x=0} = -\frac{1}{2\kappa}(\kappa + 1) \frac{d\gamma_0^-}{dt}, \quad (51)$$

### The boundary layer about the positive electrode: Inner region 1.

In this region we rescale  $x$  with  $\Gamma^{-1/2}$ , denote variables by the superscript  $(j)$  and make the following asymptotic expansion:

$$\begin{aligned} x &= 1 - \Gamma^{-1/2}z, & H^{(j)} &= H_0^{(j)} + \frac{H_1^{(j)}}{\Gamma^{1/2}} + \dots, & S^{(j)} &= S_0^{(j)} + \frac{S_1^{(j)}}{\Gamma^{1/2}} + \dots, \\ \phi^{(j)} &= \phi_0^{(j)} + \frac{\phi_1^{(j)}}{\Gamma^{1/2}} + \dots, & p &= \Gamma^{-1/2}p_0 + \dots, & \gamma^- &= \gamma_0^- + \dots. \end{aligned}$$

The analysis which follows on substitution of the above expansion into (17) and (68) is almost identical to that carried out for the inner region about the negative electrode and, in order to avoid repetition, we shall only give the results. These are listed below:

$$H_0^{(j)} = D(t) \exp(-\phi_0^{(j)}), \quad S_0^{(j)} = C(t) \exp(\phi_0^{(j)}), \quad (52)$$

$$\phi_0^{(j)} = 2 \ln \left( \left( \frac{D(t)}{C(t)} \right)^{\frac{1}{4}} \tanh \left( \frac{(C(t)D(t))^{\frac{1}{4}}}{\sqrt{2}} (z + z_1(t)) \right) \right), \quad (53)$$

$$(C(t)D(t))^{\frac{1}{4}} = -\frac{p_0}{2\sqrt{2}} \sinh \left( \sqrt{2}(C(t)D(t))^{\frac{1}{4}} z_1(t) \right). \quad (54)$$

$$\frac{3}{\kappa} \frac{d\gamma_0^+}{dt} = \left( \frac{\partial H_1^{(j)}}{\partial z} + H_0^{(j)} \frac{\partial \phi_1^{(j)}}{\partial z} + H_1^{(j)} \frac{\partial \phi_0^{(j)}}{\partial z} \right), \quad (55)$$

$$\frac{d\gamma_0^+}{dt} = \left( \frac{\partial S_1^{(j)}}{\partial z} - S_0^{(j)} \frac{\partial \phi_1^{(j)}}{\partial z} - S_1^{(j)} \frac{\partial \phi_0^{(j)}}{\partial z} \right) \quad (56)$$



### Matching inner region 1 to the outer region.

The matching proceeds in a similar manner to that of inner region 0 to the outer and gives rise to the following conditions on the outer solution:

$$\phi_0^{(c)}|_{x=1} = \frac{1}{2} \ln \left( \frac{D(t)}{C(t)} \right), \quad (57)$$

$$H_0^{(c)}|_{x=1} = S_0^{(c)}|_{x=1} = (C(t)D(t))^{1/2}, \quad (58)$$

$$\left. \frac{\partial H_0^{(i)}}{\partial x} \right|_{x=1} = - \left( \frac{3 + \kappa}{2\kappa} \right) \frac{d\gamma_0^+}{dt}, \quad (59)$$

$$H_0^{(i)} \left. \frac{\partial \phi_0^{(i)}}{\partial x} \right|_{x=1} = \left( \frac{\kappa - 3}{2\kappa} \right) \frac{d\gamma_0^+}{dt}, \quad (60)$$

### The outer region

Integrating (26) with respect to  $x$  we find

$$H_0^{(c)} \frac{\partial \phi_0^{(c)}}{\partial x} = \left( \frac{1 - \kappa}{1 + \kappa} \right) \frac{\partial H_0^{(c)}}{\partial x} + \Upsilon(t).$$

Applications of the boundary conditions (50), (51), (59) and (60) to the above equation determines  $\Upsilon(t)$  as:

$$\Upsilon(t) = - \left( \frac{2}{1 + \kappa} \right) \frac{d\gamma_0^-}{dt} = - \left( \frac{2}{1 + \kappa} \right) \frac{d\gamma_0^+}{dt},$$

from which we can conclude that

$$\frac{d\gamma_0^+}{dt} = \frac{d\gamma_0^-}{dt}, \quad (61)$$

$$\frac{\partial \phi_0^{(c)}}{\partial x} = \frac{(1 - \kappa)}{(1 + \kappa)H_0^{(c)}} \frac{\partial H_0^{(c)}}{\partial x} - \frac{2}{(1 + \kappa)H_0^{(c)}} \frac{d\gamma_0^+}{dt}. \quad (62)$$

Integrating the latter of these equations between  $x = 0$  and  $x = 1$  and substituting the boundary conditions (48), (49), (57) and (58) then gives the following relation:

$$\ln(C(t)) - \ln(A(t)) + \kappa \ln(B(t)) - \kappa \ln(D(t)) = 2 \frac{d\gamma_0^-}{dt} \int_0^1 \frac{1}{H_0^{(c)}} dx. \quad (63)$$

We now expand  $I$  as follows:

$$I = I_0 + \dots,$$

and substitute this expansion into (20) and (21) to obtain

$$\frac{d\gamma_0^-}{dt} = \frac{d\gamma_0^+}{dt} = \frac{\lambda}{2} I_0, \quad (64)$$

and into (22), together with (40), (37) and (53), to find

$$I_0 = 2 \ln \left( \left( \frac{D(t)}{C(t)} \right)^{1/4} \tanh \left( \frac{(C(t)D(t))^{1/4}}{\sqrt{2}} z_1(t) \right) \right). \quad (65)$$

In addition the chemical reaction equations (18a) and (68a) yield at leading order, on substitution of expressions for  $(H_0^{(i)}, S_0^{(i)}, \phi_0^{(i)})$  and  $(H_0^{(j)}, S_0^{(j)}, \phi_0^{(j)})$ ,

$$\frac{A(t)}{B(t)} = k_0 \gamma_0^-, \quad k_1 D(t)^2 C(t)^2 = \gamma_0^+ \tanh^4 \left( \frac{(C(t)D(t))^{1/4}}{\sqrt{2}} z_1(t) \right). \quad (66)$$

### Summary of the simplified model

We now summarise equations (25), (39), (40), (49), (50), (58), (59), (61), (63), (64), (65) and (66) comprising the simplified model. These are listed below.

$$\frac{\partial H_0^{(c)}}{\partial t} \left( 1 + \frac{1}{\kappa} \right) = 2 \frac{\partial^2 H_0^{(c)}}{\partial x^2}, \quad (67)$$

$$\left. \frac{\partial H_0^{(c)}}{\partial x} \right|_{x=0} = \frac{\lambda I_0}{4\kappa} (\kappa - 1), \quad (68)$$

$$\left. \frac{\partial H_0^{(c)}}{\partial x} \right|_{x=1} = -\frac{\lambda I_0}{4\kappa} (\kappa + 3), \quad (69)$$

$$H_0^{(c)} \Big|_{x=0} = (A(t)B(t))^{1/2}, \quad (70)$$

$$H_0^{(c)} \Big|_{x=1} = (C(t)D(t))^{1/2}, \quad (71)$$

$$\lambda I_0 \int_0^1 \frac{dx}{H_0^{(c)}} = \ln(C(t)) - \ln(A(t)) + \kappa \ln(B(t)) - \kappa \ln(D(t)), \quad (72)$$

$$I_0 = 2 \ln \left( \left( \frac{D(t)}{C(t)} \right)^{1/4} \tanh \left( \frac{(C(t)D(t))^{1/4}}{\sqrt{2}} z_1(t) \right) \right), \quad (73)$$

$$\left(\frac{A(t)}{B(t)}\right)^{1/4} = \tanh\left(\frac{(A(t)B(t))^{1/4}}{\sqrt{2}}z_0(t)\right), \quad (74)$$

$$\frac{A(t)}{B(t)} = k_0\gamma_0^-, \quad (75)$$

$$k_1D(t)^2C(t)^2 = \gamma_0^+ \tanh^4\left(\frac{(C(t)D(t))^{1/4}z_1(t)}{\sqrt{2}}\right), \quad (76)$$

$$\frac{d\gamma_0^-}{dt} = \frac{d\gamma_0^+}{dt} = \frac{\lambda}{2}I_0, \quad (77)$$

$$f_0 = \frac{2\sqrt{2}(A(t)B(t))^{1/4}}{\sinh\left(\sqrt{2}(A(t)B(t))^{1/4}z_0(t)\right)}, \quad (78)$$

$$p_0 = -\frac{2\sqrt{2}(C(t)D(t))^{1/4}}{\sinh\left(\sqrt{2}(C(t)D(t))^{1/4}z_1(t)\right)}. \quad (79)$$

The problem has been reduced to that of solving the linear diffusion equation (67), subject to boundary conditions which require solving equations (68) to (79) simultaneously. Suitable initial conditions for a charged battery that begins to be discharged at time zero are to take  $\gamma^\pm = 0$ , and  $H$  and  $S$  to be one. Charging is a matter of reversing current flow. One way to use this model for our problem is to specify the current drawn from the battery, and to solve for the voltage.

#### 4. A Simpler Chemical Model

A model was developed that assumes the rate-limiting processes are the chemical reactions at the plates. Subsequent literature searches reveal that the time constants for lead dioxide are of the order of seconds (3), suggesting that the transport of electrolyte is the rate-determining process, as modelled in the previous section. Hence we will not present this work here.

#### 5. A Hydraulic Model

The hydraulic model given by Manwell and McGowan, (6) divides the battery into two compartments, one holding charge that is immediately available,  $q_1(t)$ , and the other holding chemically bound charge,  $q_2(t)$ , that takes longer to become available, as illustrated schematically in figure 4. Both compartments have height one. The outer compartment has surface

area  $c$ , and the inner has area  $1 - c$ . The constant  $c \in [0, 1]$  proportions the battery according to how much charge is immediately available, compared with total available charge. The "head" that drives ion flow is  $h_1 = q_1/c$  in the outer compartment, and  $h_2 = q_2/(1 - c)$  in the inner compartment. The conductance between the two compartments is  $k'$ .

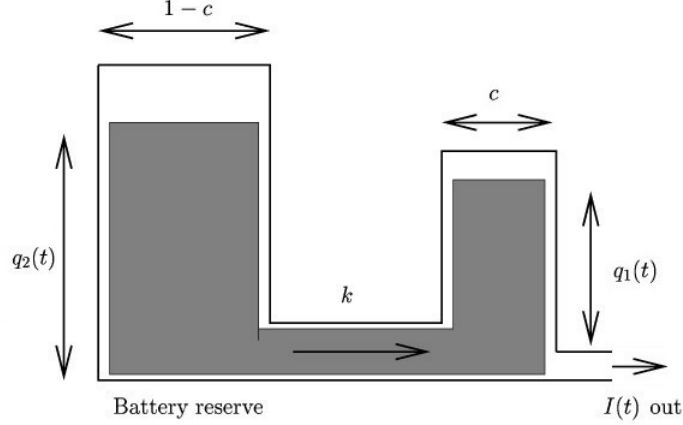

Figure 4: Battery model showing total charge in two compartments, one with immediate charge and the other with chemically bound charge.

Then the hydraulic model equations are

$$\frac{dq_1}{dt} = -I(t) - k'(h_1 - h_2), \quad (80)$$

$$\frac{dq_2}{dt} = k'(h_1 - h_2). \quad (81)$$

Defining a new rate constant,

$$k = \frac{k'}{c(1 - c)},$$

leads to the following form for the governing equations for the system:

$$\frac{dq_1}{dt} = -I(t) - k(1 - c)q_1 + kcq_2, \quad (82)$$

$$\frac{dq_2}{dt} = k(1 - c)q_1 - kcq_2, \quad (83)$$

where the current drawn  $I(t)$  is also found by simple rearrangement as

$$I(t) = - \left( \frac{dq_1}{dt} + \frac{dq_2}{dt} \right). \quad (84)$$

The voltage,  $V(t)$  is given by

$$V(t) = \beta + \alpha q_1(t) - I(t)R_0. \quad (85)$$

The forms for the constants  $\beta$  and  $\alpha$  are

$$\beta = E_{min}, \quad \alpha = \frac{(E_{0,d} - E_{min})}{q_{1m}} \quad (86)$$

for discharging and for charging

$$\beta = E_{0,c}, \quad \alpha = \frac{(E_{max} - E_{0,c})}{q_{1m}}. \quad (87)$$

The definitions of the various constants are that  $E_{min}$  is the minimum allowed discharge voltage ('empty'),  $E_{0,d}$  the maximum internal discharge voltage ('full'),  $E_{max}$  the maximum charging voltage,  $E_{0,c}$  the minimum charging voltage,  $q_{1m}$  the maximum value of  $q_1(t)$ .

Manwell and McGowan, 1991, solved the above equations for constant  $I(t)$ , and constant  $k$  and used their solutions to find expressions for the various unknown constants such as  $q_{1m}$ .

Finding the solution for constant  $k$  but non constant  $I(t)$  is a simple Laplace transform problem yielding the solution

$$\begin{aligned} q_1(t) = & 2c \sinh \left( \frac{kt}{2} \right) e^{-kt/2} (q_1(0) + q_2(0)) + q_1(0) e^{-kt} \\ & - c \int_0^t I(u) du - (1-c) \int_0^t I(u) e^{k(u-t)} du, \end{aligned}$$

and similarly for  $q_2$ .

However it is not clear that  $k$  should be a constant. If  $k = k(t)$  is a known function then solution of the above system of differential equations is relatively easy using Matlab programming. Unfortunately the precise form for  $k(t)$  may not be known.

We suggest the problem be reversed, so that instead of using a constant  $k$  to predict  $V(t)$  given an  $I(t)$ , the voltage and currents are used to find

$k(t)$ . Once a dependable form for  $k(t)$  is known, then this can be used to better predict future voltage and current values.

From equation (83) we have

$$k = \frac{\frac{dq_2}{dt}}{q_1 - c(q_1 + q_2)}, \quad (88)$$

but using equation (84) this can be written as

$$k = \frac{-I(t) - \frac{dq_1}{dt}}{q_1 + c\left(\int_0^t I(u) du - c_1\right)} \quad (89)$$

where  $c_1 = q_1(0) + q_2(0)$  is an integration constant. Using equation (85) the final expression is

$$k(t) = \frac{-\alpha I(t) - \left(\frac{dV}{dt} + \frac{dI}{dt} R_0\right)}{V(t) - \beta + I(t)R_0 + c\alpha \int_0^t I(u) du - c_2}, \quad (90)$$

where  $c_2 = c\alpha(q_1(0) + q_2(0))$ .

Thus, theoretically, given data for  $V(t)$  and  $I(t)$  and the various parameters,  $k(t)$  can be found. There are two main difficulties with this operation. First, the data for  $V(t)$  and  $I(t)$  must be suitable for differentiation and integration, which will usually require the fitting of splines through the data. Care must be taken to make sure the approximation spline accurately represents the data, while still allowing relatively smooth and continuous derivatives.

The second difficulty lies in estimating the constants  $c, \alpha, \beta, q_1(0), q_2(0)$ . Accurate measurements of these using the model above is a separate challenge beyond the scope of this current work.

## 6. A Parametric Model

The *Battery Energy Storage Test Facility* model (“BEST” model) was developed by the US Department of Energy to model parametrically the

behaviour of lead-acid storage batteries (6; 7). The model equations are

$$V = E - IR_0 \quad (91)$$

$$E = E_0 - \frac{AX}{Q_0} - \frac{MX}{Q_0 - X} \quad (92)$$

$$X = q + \frac{DIq + (1 - D) \langle IQ \rangle}{I_0} \quad (93)$$

$$\langle IQ \rangle = \int_0^q \left( \frac{q - q'}{t - t'} \right) dq' \quad (94)$$

where  $R_0$  is the internal resistance of the battery ( $0.04\text{m}\Omega$ ),  $E$  is the theoretical battery voltage (if there is zero internal resistance),  $E_0$  is the battery voltage at zero current ( $2.14\text{V}$ ),  $Q_0$  is the capacity limit ( $50.9$  kilo Ampere-hours) at zero current,  $q$  is the number of ampere-hours discharged at time  $t$ ,  $q'$  is the number of ampere-hours discharged at the previous times  $t'$ ,  $X$  is called the effective discharge,  $I$  is the current drawn from the battery,  $V$  is the measured voltage across the battery, and  $\langle IQ \rangle$  takes account of the history of the battery. The four parameters  $A$ ,  $M$ ,  $D$ , and  $I_0$ , are to be fitted to the charge/discharge data.

This parametric model has been found to have appropriate behaviour, such as a gradual decline in voltage versus discharge, up to a critical value when voltage drops right away, and the correct (concave upwards) slope of plots of capacity versus discharge current.

This model looks promising, as it should be straight-forward to fit the four parameters, it is easy to programme, it is designed to handle variable discharge histories, and it is also designed to allow for recharging. Uncertainties to be determined are how robust the parameters are (e.g. to changing battery age), whether the model is adequate for modelling the effects of lead sulphate buildup, and what effect temperature would have on the parameter values.

The figures presented here show model behaviours for a test problem, at constant discharge current, and at constant discharge power ( $240$  ampere-volts). More work is needed to see if the model is going to be useful in this application.

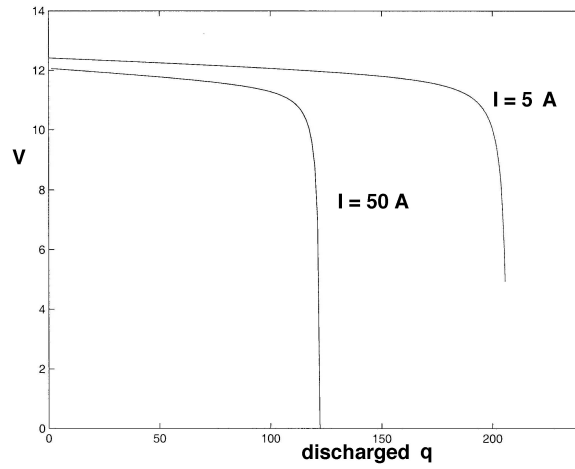

Figure 5: Voltage versus discharge at constant current, using the “BEST” model.

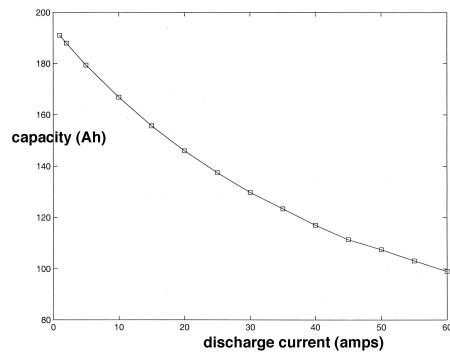

Figure 6: Battery capacity versus constant discharge current, using the “BEST” model.



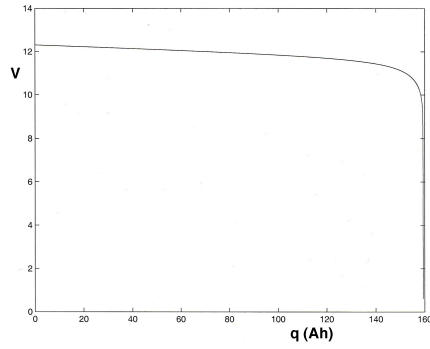

Figure 7: Battery voltage versus discharged ampere-hours when discharging at constant power, using the “BEST” model.

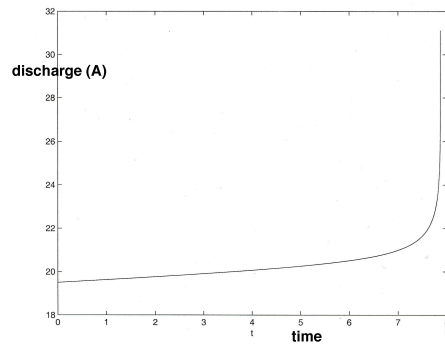

Figure 8: Battery current versus time when discharging at constant power, using the “BEST” model.

## 7. Conclusions and recommendations

Three different models for the discharge and charge of lead-acid batteries under deep cycling conditions were considered in depth. Some good progress was made, especially with asymptotic solutions for the boundary layers that develop in the detailed electrochemical model, and in extending the hydraulic model to the case of a variable  $k$ . More work is needed, especially in fitting models to actual battery performance data, to see which model is the most accurate and robust.

## Acknowledgements

The moderators for this problem, Mark McGuinness and Basil Benjamin, are grateful to the large number of willing workers who tackled various approaches to modelling batteries, including Jooyoung Hahn, Zen Lu, Giles Richardson, Geoff Mercer, Steve Barry, Tim Marchant, Mark Nelson, Xuan Vu, Neil McGillivray, Steve McAuley, Fuchun Huang, Grant Cox, Ian Coope, Neville Fowkes, John King, Kil Kwon, and Peter Pudney.

Detailed followup notes for two of the models presented in this report were provided by Giles Richardson and Steve Barry.

We are particularly grateful to Peter Tromans and Glenn Bate from ASC for their patience and hard work all week.

## References

- [1] Gu, W.B., Wang, C.Y., and Liaw, B.Y., “Numerical modelling of coupled electrochemical and transport processes in lead-acid batteries”, *J. Electrochem. Soc.* **144(6)** (1997) 2053–2061.
- [2] Bernadi, D.M., Gu, H., and Schoene, A.Y., “Two-dimensional mathematical model of a lead-acid cell”, *J. Electrochem. Soc.* **140(8)** (1997) 2250–2258.
- [3] Srinivasan, V., Wang, G.Q., and Wang, Y.C., “Mathematical modelling of current-interrupt and pulse operation of valve-regulated lead acid cells”, *J. Electrochem. Soc.* **150(3)** (2003) A316–A325.

- [4] Atkins, P., and de Paula, J., “Atkins’ Physical Chemistry Seventh Edition”, OUP 2001.
- [5] Deen, W.P., “Analysis of Transport Phenomena”, OUP 1998.
- [6] Manwell, J.F. and McGowan, J.G., “Lead acid battery storage model for hybrid energy systems”, *Solar Energy*, **50** (1991), 399–405.
- [7] Hyman, E., “Modeling and computerized characterization of lead-acid battery discharges,” BEST Facility Topical Report RD 83-1, NTIS Report DOE/ET/29368-T13 (1986).